

functionaleducation®

3D® 1ST PHASE FIXED/REMOVABLE® (WILSON®)

Without changing your chosen technique, RMO® 3D® 1st Phase FIXED/REMOVABLE® Modular Orthodontics™ (Wilson®) can help your practice target treatment planning decisions to reduce treatment time and cost, and to improve patient comfort and cooperation. This will help your practice grow.

All principles have been proven through successful usage for many decades. What is new and unique is the way the principles were engineered by Dr. William Wilson and Dr. Robert Wilson into an easy-to-use plug-in, plug-out system of 12 modular options. Over 100 different 1st Phase treatment movements can be achieved with minimum number of appliances and maximum patient comfort and satisfaction.

The 3D Lingual Arch System (Wilson) is the result of four decades of lingual arch use, analysis and research, change and experimentation. All types of non-bracket lingual appliances and molar band/tube combinations were evaluated. Different orthodontic mechanical needs and possibilities were considered. The originators, Dr. William Wilson and Dr. Robert Wilson were also concerned with harmonious lingual arch usage with various types of fixed and removable techniques.

In perspective, the 3D FIXED/REMOVABLE System (Wilson) should be considered as a comprehensive appliance supplementing system; it is a "tool box" of options. The numerous 3D options help you add to the effectiveness of the appliances you have chosen to deal with your diagnosis and treatment plan. Also, it is important to note that each 3D module is a subsystem by itself. That is, each has specific areas for use and each has numerous supplementing options.

While a 3D Lingual Arch can be cut in half and used with acrylic to make a Nance Holding Appliance for maxillary arches, this 3D Lingual Arch is designed primarily for mandibular arches. The same is true for the 3D Quad-Action Mandibular Appliance.

3D Lingual appliances for the various maxillary arch needs are: the 3D Palatal Appliance, 3D Multi-Action Palatal Appliance and the Quad Helix.

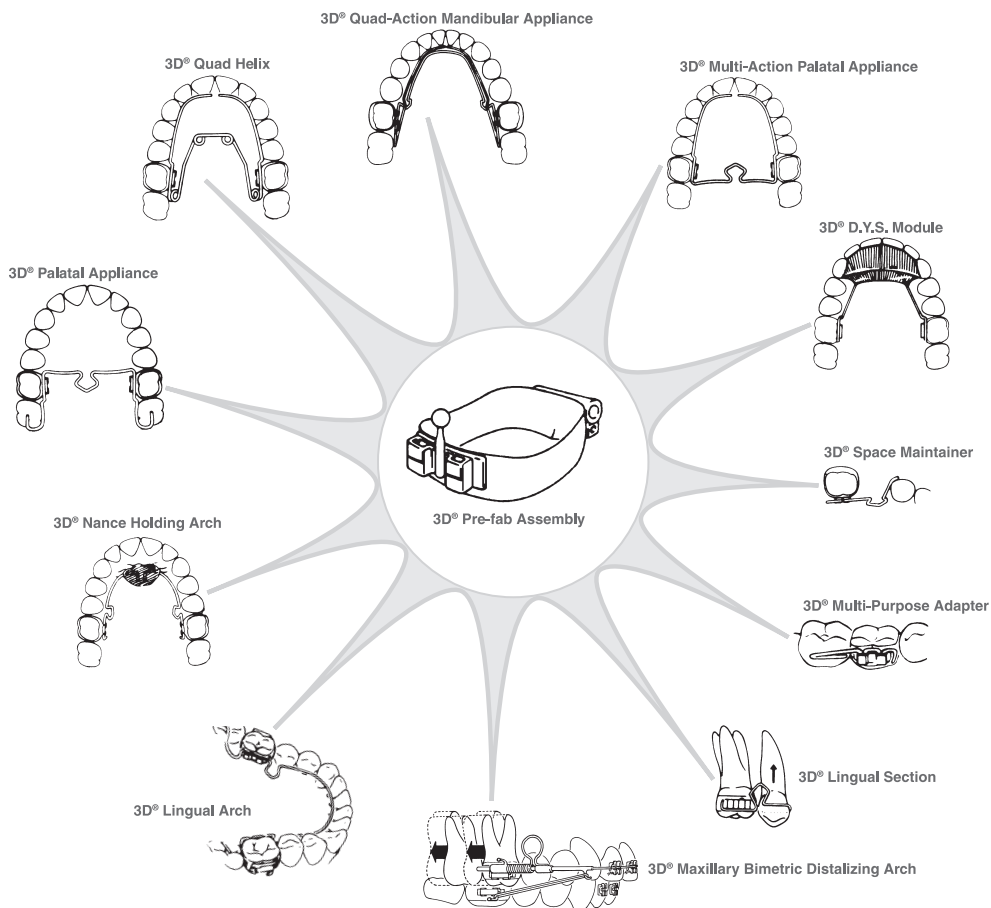

Like most things found in the dental profession, successful use depends upon understanding and development of skills. The following are educational materials and services.

Basic Textbooks: By Dr. Robert Wilson and Dr. William Wilson

Book 1 Enhanced Orthodontics

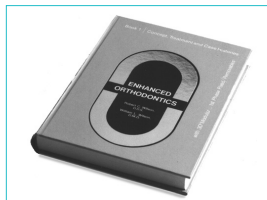

This book reviews basic concepts and describes how the different modules affect 100 different 1st Phase treatment movements. Twenty case histories are described and documented. 435 pages, 700 illustrations.

Order Number **P00040**

Book 2 Enhanced Orthodontics: 3D® Multi-Directional Force Systems Fabrication



This laboratory manual illustrates and describes step-by-step how the 3D Modules are adapted and used. It is a "how to" book on making modular appliances.

Order Number **P00042 - available on Website download only**

3D® Wilson® Toolbox

The Wilson Toolbox contains an assortment of the most popular sizes of appliances conveniently packaged to begin using the system.

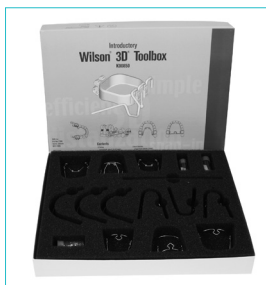

Order Number	Kit Components	
3D® Wilson® Toolbox	K00850	
A04303	3D® Lingual Arch Size 4	1 each
A04304	3D® Lingual Arch Size 5	1 each
A04305	3D® Lingual Arch Size 6	1 each
A04157	3D® Maxillary Bimetric Distalizing Arch Size 3	1 each
A04158	3D® Maxillary Bimetric Distalizing Arch Size 4	1 each
A04159	3D® Maxillary Bimetric Distalizing Arch Size 5	1 each
A04310	3D® Quad Helix Size 3	1 each
A04311	3D® Quad Helix Size 4	1 each
A04312	3D® Quad Helix Size 5	1 each
A04322	3D® Multi-Action Palatal Appliance Size 3	1 each
A04323	3D® Multi-Action Palatal Appliance Size 4	1 each
A04324	3D® Multi-Action Palatal Appliance Size 5	1 each
F00125	Elgiloy® Coil Spring 5mm	10 each
F00126	Orthono® Coil Spring 5mm	10 each
A04315	3D® Wilson® Lingual Tube	20 each
i00505	3D® Lingual Arch Selector	1 each
i00507	3D® Maxillary Bimetric Distalizing Arch Selector	1 each

3D® Transfer System Overview

The key to in-practice and laboratory 3D Appliance processing.

- Preformed bands with 3D Lingual Tubes and buccal tubes with .045" or .051" headgear tubes of your choice are fitted and cemented.
- If molars are rotated, making it difficult for 3D Maxillary Bimetric Distalizing Arches to be fitted into the headgear tubes, adjust as follows:
 - Form an .018" molar rotating arch with horizontal helices just anterior to the "toed-in" headgear tube. Bend the distal ends of the arch wire to accomplish the desired rotations so the posterior sections can be easily placed into the headgear tubes.
 - Tie-in arch wire. When molars have rotated as desired, remove the arch wire. You are now ready to employ the 3D Transfer System.

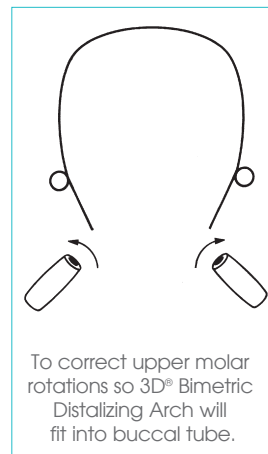

3D® Transfer System

	Order Number	Package Contains
3D® Transfer Insert	A04198	10
3D® Transfer Lingual Tube	A04199	10

- Reduces time consuming laboratory related procedures
- Laboratory impression can be taken during active treatment (No need to stop treatment)
- Laboratory can produce very accurate FIXED/REMOVABLE appliance
- A time/cost saver; excellent for in-practice and outside 3D laboratory appliance fabrication procedures

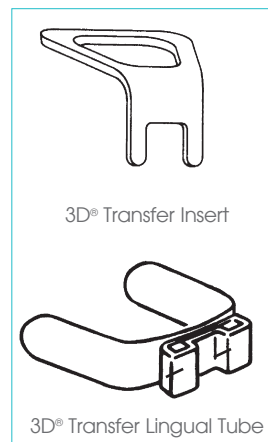

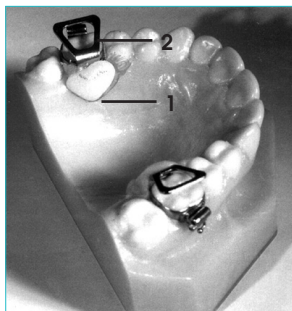

Office Procedures

RMO® TruForm Molar Bands, prewelded with buccal tubes and 3D® Lingual Tubes have been cemented in place on the patient.

1. The 3D Lingual Tubes are covered with wax.
2. Insert the 3D Transfer Inserts into the 3D Lingual Tubes. The posts are designed as loose-positioning posts for the 3D Transfer System, and not as the friction-fit posts in the 3D appliances.
3. Take soft colloid impression and remove after setting. Note how the insert posts are protruding through the impression.
4. The impression is now sent to the laboratory for 3D appliance fabrication.

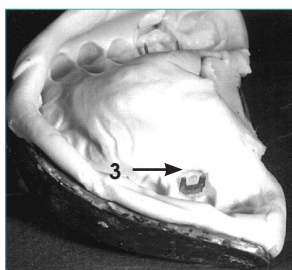

Laboratory Procedures

Doctor sends in an impression with 3D Transfer Inserts already in position.

5. With scalpel, remove 3mm of colloid, lingual to the posts, for seating clearance.
6. Seat the 3D Transfer Lingual Tubes on the protruding posts. If necessary, contour the retaining tabs of the 3D Transfer Tube to insure retention in the stone model.
7. Add sticky wax over the 3D Lingual Tubes and fill the space between the tubes and colloid.
8. Pour with stone and separate. The 3D Transfer Lingual Tubes will be accurately positioned and securely attached to the stone model.
9. Proceed to fabricate the 3D appliance on the stone model.
10. With knife, remove the 3D Transfer Inserts from the colloid. Also, remove the 3D Transfer Lingual Tubes from the stone formed for future reuse or retain in stone model for future 3D modular components.
11. For commercial laboratories, send the finished 3D appliance to the doctor on the stone model for reference.

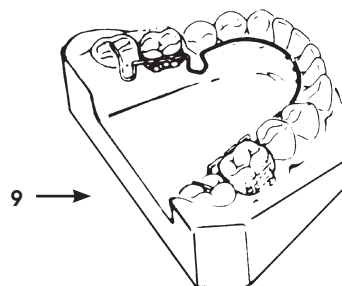
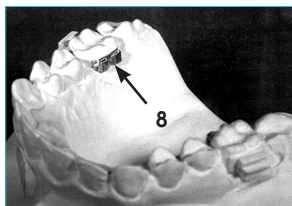
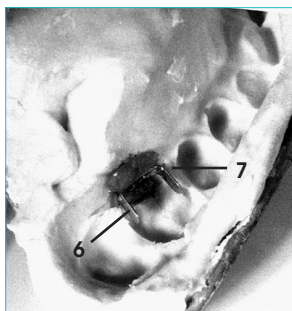
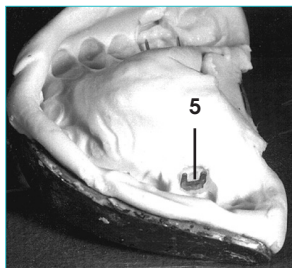

functionaleducation®

3D® LINGUAL AND BUCCAL TUBES (WILSON®)

3D® Lingual Tube (Wilson®)

The key to the 1st Phase System (Wilson) is the 3D Lingual Tube. All 3D lingual modules plug into these tubes. They are available with and without prewelded hooks. They can be purchased separately or as a preweld on RMO TruForm Molar Bands.

- New, improved “click-fit” assures positive post seating

	Order Number	Package Contains
3D® Lingual Tube	A04315	10
3D® Lingual Tube with Gingival Hook	A04314	10

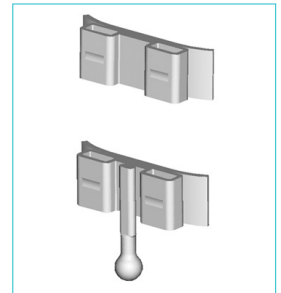

3D® Buccal Tubes (Wilson®) – Maxillary

The 3D Wilson Maxillary Double Buccal Tubes are available with 6° Distal Offset. These tubes are designed with .018" x .030" (.457mm x .762mm) or .022" x .030" (.559mm x .762mm) dimensions and an extra long extended gingival .045" (1.143mm) round headgear tube to help prevent tipping of the molar when distalizing.

The 6° Distal Offset tube is produced as an integrated one-piece design, utilizing state-of-the-art Metal Injection Molding (MIM) manufacturing. The rectangular tube is approximately 2mm shorter than the headgear (round) tube, to increase the inter-tube distance with the 2nd molar. The rectangular tube is convertible, with an integrated tie wing design. It is available with a hook.

		On Bases	Tubes Only/ On Bands	On Bases	Tubes Only/ On Bands	Package Contains
		.018 (.457mm)		.022 (.559mm)		
With Hook	R	A08260	A04360	A08262	A04362	10
	L	A08261	A04361	A08263	A04363	10



3D® Buccal Tubes (Wilson®) – Mandibular

The 3D Wilson Mandibular 1st Molar Tube consists of two rectangular arch slots with a mesial hook. The reduced friction slot reduces corner drag when using square or rectangular wire. Smooth buccal surface; rounded edges for patient comfort. Increased mesial distal length for increased control.

		Order Number	Package Contains
		.018 (.457mm)	.022 (.559mm)
With Hook	R	A04370	A04372
	L	A04371	A04373

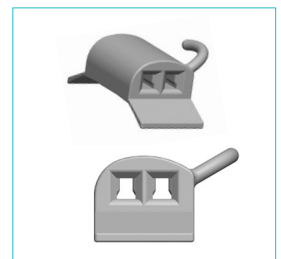

Buccal Tubes

However Dr. Wilson recommends the use of buccal tubes with gingivally placed .045" head gear tubes, other buccal tubes of various fixed appliances with occlusally placed headgear tubes can be successfully used with 3D Maxillary Bimetric Distalizing Arch procedures.

When using 3D Maxillary Bimetric Distalizing Arches with .045" or .051" occlusally placed buccal tubes, it is necessary to adjust the distal buccal section of the arch. A step up bend is made anterior to the Omega Stop assembly. This enables the distalizing elements to function in the occlusally placed tube while the anterior elements of the arch are properly aligned with anterior brackets.

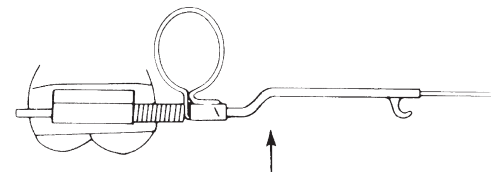

RMO® now has buccal tubes and tube variations for all popular techniques. If your practice is interested in incorporating selected 3D 1st Phase FIXED/REMOVABLE (Wilson) options into your treatment regimens, it is easily done. Just order 3D Lingual Tubes and your preferred buccal tubes prescription welded to RMO TruForm Molar bands.

FUNCTIONALEUCATION®

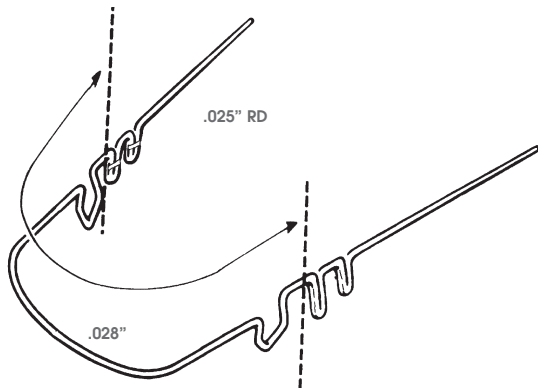

3D® Lingual Arch

- Easy vertical placement and removal
- Mandibular anchorage
- Holding arch for extraction and non extraction cases
- Mandibular arch length increase, including slight molar distalization, one side at a time
- Lower molar rotation, torquing and tipping
- Second molar control

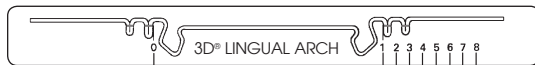

Size	Order Number	Package Contains	Kit Contains
1 - 51mm	A04300	3	2
2 - 54mm	A04301	3	3
3 - 57mm	A04302	3	4
4 - 60mm	A04303	3	6
5 - 63mm	A04304	3	6
6 - 66mm	A04305	3	4
7 - 69mm	A04306	3	3
8 - 72mm	A04307	3	2
9 - 75mm	A04318	3	-
10 - 78mm	A04319	3	-
Assorted	K00760	-	30
3D® Lingual Arch Selector	i00505	1	

3D® Maxillary Bimetric Distalizing Arch

- Rapid molar distalizing (no headgear required)
- Rapid anterior retraction (no headgear required)
- Rapid anterior intrusion (no headgear required)
- Functional arch increase
- Release of post-lock mandible to allow forward growth

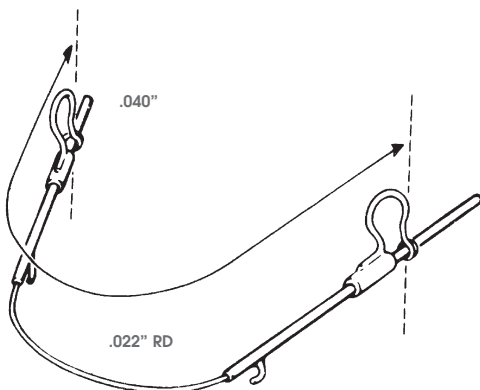

Size	Order Number	Package Contains	Kit Contains
1 - 80mm	A04155	3	1
2 - 83mm	A04156	3	1
3 - 86mm	A04157	3	2
4 - 89mm	A04158	3	3
5 - 92mm	A04159	3	3
6 - 95mm	A04160	3	2
7 - 98mm	A04161	3	2
Assorted	K00678	-	14
3D® Maxillary Bimetric Distalizing Arch Selector	i00507	1	

functionaleducation®

3D® FIXED/REMOVABLE® (WILSON®) COMPONENTS

3D® Bimetric Arch (basic)

- For making a 3D Maxillary Bimetric Distalizing Arch
- Same as 3D Maxillary Bimetric Distalizing Arch plus special applications in unilateral distalization

Size	Order Number	Package Contains	Kit Contains
1 - 40mm	A04127	3	1
2 - 43mm	A04128	3	2
3 - 46mm	A04129	3	3
4 - 49mm	A04150	3	3
5 - 52mm	A04151	3	3
6 - 55mm	A04152	3	2
7 - 58mm	A04153	3	1
8 - 58mm	A04154	3	0
with extended section (6mm) each side			
Assorted	K00688	-	15
3D® Bimetric Arch Selector	i00506	1	

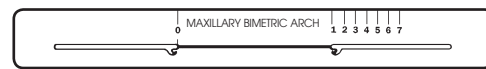
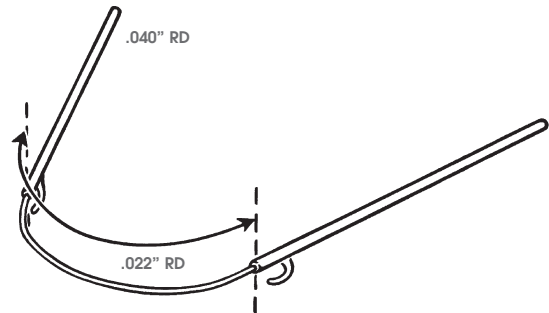

	Order Number	Package Contains
Omega Adjustable Stop	A04124	10

- Crimpable .040 ID
- Use the i00548W modular Omega plier for adjustments



5mm Coil Spring

Open Elgiloy® coil spring. Does not require heat treatment. For use with Bimetric Distalizing Arch.

.010" x .045" x 5mm	F00125	50
---------------------	---------------	----

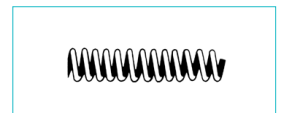

Open Orthono® Coil Spring, constant force gradient of nickel titanium when distalizing (Schedule II elastics only).

.012" x .045" x 5mm	F00126	10
---------------------	---------------	----

Energy Pak™ Elastics

	Order Number	Package Contains (approximately)
Nonextraction cases		
5/16" 2 oz.	J01103	2,000
5/16" 3 oz.	J01113	2,000
Extraction cases		
1/4" 2 oz.	J01102	2,000
1/4" 3 oz.	J01112	2,000

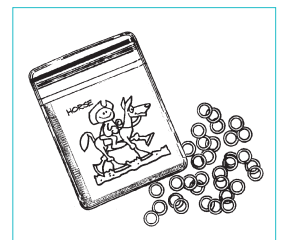

Elastic Load Reduction Principle For the 3D® Maxillary Bimetric Distalizing Arch

SCHEDULE #1 (2 oz. elastics)

Used with:

- Flaring lower incisors
- Small mandibular roots

First	Second	Last
5 days of treatment use:	5 days of treatment use:	11 days or until next visit use:
3 - 2 oz. elastics	2 - 2 oz. elastics	1 - 2 oz. elastics

Using 2 oz elastics, three elastics should be used during the first five days, two during the second five days and one during the final eleven days of the treatment plan. Fresh elastics are applied daily. Elastics must be worn 24 hours each day between appointments, including during meals.

Use RMO® 5/16" 2 oz. elastics for non-extraction cases.

Order No. **J01103**

Use RMO® 1/4" 2 oz. elastics for extraction cases.

Order No. **J01102**

SCHEDULE #2 (3 oz. elastics)

Most common usage:

- Class II Div. 2
- Class II Div. 1 with closed bite
- Cases with steep cusps
- Adult cases

First 10 days of treatment use:	Until next visit use:
2 - 3 oz. elastics	1 - 3 oz. elastics

Two RMO® 3 oz. elastics used during the first 10 days. Then, one 3 oz. elastic is worn until next adjustment. Fresh elastics are applied each 12 hours and are worn 24 hours daily, including during meals.

Use RMO® 5/16" 3 oz. elastics for nonextraction cases.

Order No. **J01113**

Use RMO® 1/4" 3 oz. elastics for extraction cases.

Order No. **J01112**

functionaleducation®

3D® FIXED/REMOVABLE® (WILSON®) COMPONENTS

3D® Quad Helix

- Easy vertical placement and removal
- A single FIXED/REMOVABLE alternative to multiple removable appliances
- Bilateral molar expansion
- Bilateral maxillary arch expansion
- Molar rotation, torquing and tipping
- Selective cuspid and bicuspid expansion
- Excellent for correcting cross bites in pediatric dental patients

Size	Order Number	Package Contains	Kit Contains
1 - 25mm	A04308	3	1
2 - 27mm	A04309	3	1
3 - 31mm	A04310	3	1
4 - 34mm	A04311	3	1
5 - 37mm	A04312	3	1
6 - 40mm	A04313	3	1
Assorted	K00770	-	6

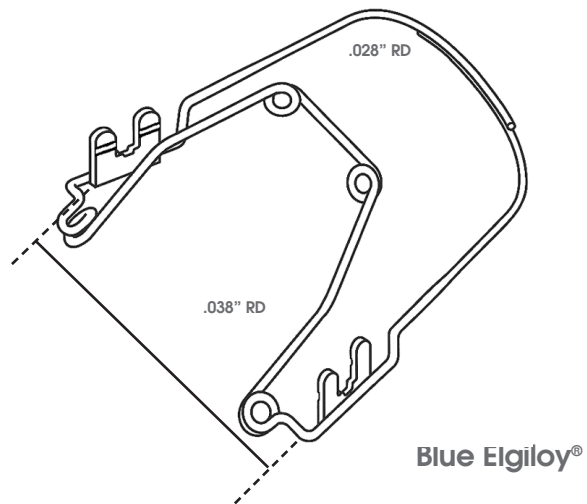

3D® Multi-Action Palatal Appliance

- Some clinicians have expressed a need for a less complex expansion appliance; this is the alternative to the Quad Helix
- Excellent for adult orthodontics
- Easy vertical placement and removal
- More than just a palatal arch
- A single FIXED/REMOVABLE alternative to multiple removable appliances
- Total maxillary arch expansion
- Selective cuspid and bicuspid expansion
- All major rotations, torquing and tipping

Size	Order Number	Package Contains	Kit Contains
1 - 32mm	A04320	3	1
2 - 36mm	A04321	3	1
3 - 40mm	A04322	3	1
4 - 44mm	A04323	3	1
5 - 50mm	A04324	3	1
6 - 56mm	A04325	3	1
Assorted	K00780	-	6

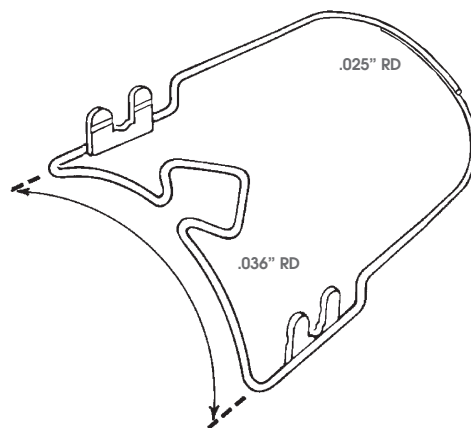

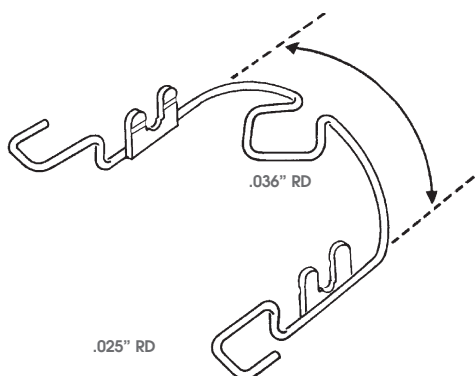

3D® Palatal Appliance

- Easy vertical placement
- Transpalatal arch
- Molar expansion or contraction
- High pull headgear control
- Molar rotation, torquing and tipping
- Molar expansion
- Palatal cusp intrusive action to offset extrusive action during high pull headgear usage

Size	Order Number	Package Contains	Kit Contains
1 - 32mm	A04330	3	1
2 - 36mm	A04331	3	1
3 - 40mm	A04332	3	1
4 - 44mm	A04333	3	1
5 - 50mm	A04334	3	1
6 - 56mm	A04335	3	1
Assorted	K00790	-	6

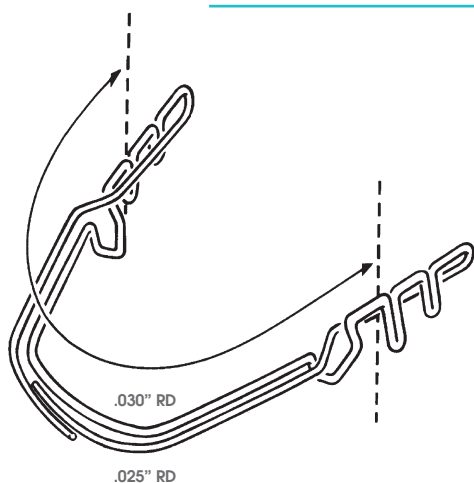

3D® Multi-Action Mandibular Appliance

- Easy vertical placement and removal
- Solves many problems for those using Crozat-type appliances
- Arch expansion
- Selective expansion
- Incisor advancement
- Slight molar distalization (one side at a time)
- Lower molar rotation, torquing and tipping

Size	Order Number	Package Contains	Kit Contains
1 - 51mm	A04340	3	1
2 - 54mm	A04341	3	1
3 - 57mm	A04342	3	1
4 - 60mm	A04343	3	1
Assorted	K00795	-	4

functionaleducation®

3D® FIXED/REMOVABLE® (WILSON®) COMPONENTS

3D® Sectional

- Easy vertical placement and removal
- Impacted cuspid activator
- Simple expander
- Simple bicuspid space maintainer
- Simple bicuspid space regainer
- Cantilever resistor, molar tip-back resistor

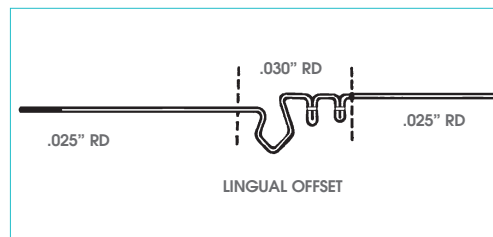

	Order Number	Package Contains
Maxillary Right/Mandibular Left	A04345	5
Maxillary Left/Mandibular Right	A04346	5

3D® Adapter

- Easy vertical placement and removal
- Simple space maintainer
- Mandibular molar tip-back resistor
- Maxillary molar tip-back resistor
- Cross elastic hook
- Simple expander

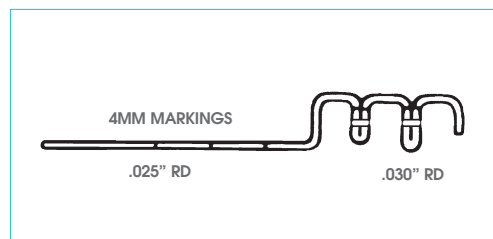

	Order Number	Package Contains
Maxillary Right/Mandibular Left	A04347	5
Maxillary Left/Mandibular Right	A04348	5

3D® Space Maintainer

- Easy vertical placement and removal
- Second bicuspid space regainer
- Temporary FIXED/REMOVABLE functional space maintainer/bridge

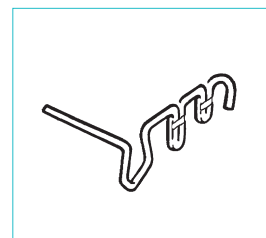

	Order Number	Package Contains
Maxillary Right/Mandibular Left	C00131	5
Maxillary Left/Mandibular Right	C00132	5



3D® D.Y.S. Module

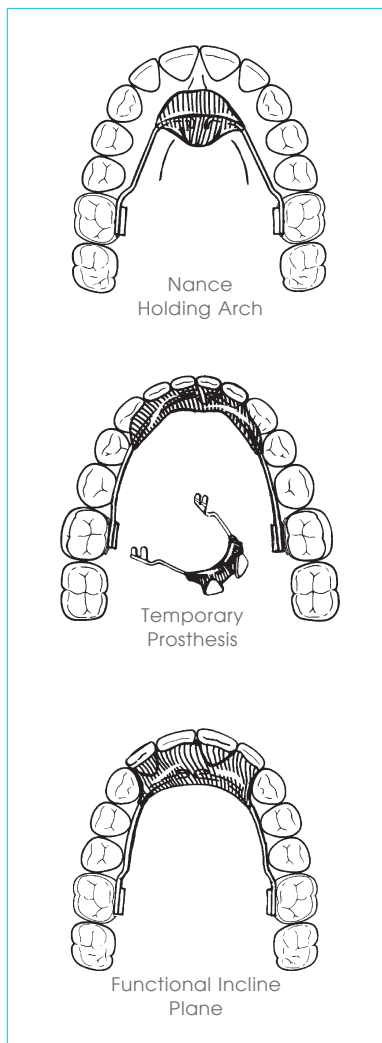

- The 3D D.Y.S. (Do-It-Yourself) Module (Wilson) provides a basic module from which a variety of individual upper and lower FIXED/REMOVABLES can be fabricated. One unit is for upper right and lower left. The other unit is for upper left and lower right. The 3D D.Y.S. Module is available in .036" and .040" TRU-CHROME Stainless Steel. All wire sizes are laser welded to the 3D Posts, which plug into the 3D Lingual Tubes. The many creative ways this 3D Module can be used in individualized FIXED/REMOVABLE appliance construction are limited only by one's imagination
- Easy vertical placement
- Universal lingual attachment
- Multiple FIXED/REMOVABLE laboratory fabricated appliances to suit numerous individual needs

	Wire Size	Order Number	Package Contains
Maxillary Right/Mandibular Left	.036	A04350	5
Mandibular Right/Maxillary Left	.036	A04351	5
Maxillary Right/Mandibular Left	.040	A04352	5
Mandibular Right/Maxillary Left	.040	A04353	5

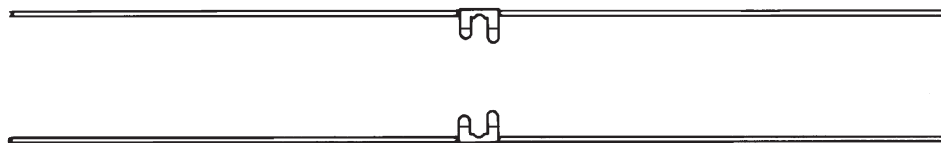

functionaleducation®

3D® WILSON®/DILLEHAY LINGUAL ARCH VARIATIONS

3D® Wilson®/Dillehay Lingual Arch – straight length

- .036" diameter Blue Elgiloy (not heat-treated)
- Laser-welded posts
- Step down bends for proper positioning at cingulum

Size	Order Number	Package Contains
3 - 57mm	A04265	5
4 - 60mm	A04266	5
5 - 63mm	A04267	5
6 - 66mm	A04268	5
7 - 69mm	A04269	5
8 - 72mm	A04270	5
9 - 75mm	A04271	5
10 - 78mm	A04272	5

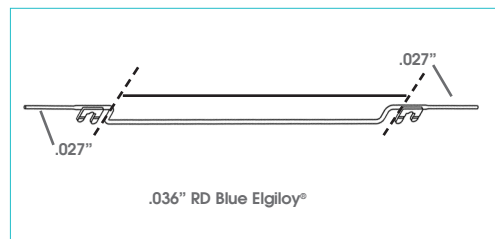

3D® Wilson®/Dillehay Preformed Lingual Arch – with distal extension

- .036" diameter Blue Elgiloy (not heat-treated)
- Easy vertical placement and removal
- Distal extension for molar uprighting

Size	Order Number	Package Contains
3 - 57mm	A04278	3
4 - 60mm	A04279	3
5 - 63mm	A04280	3
6 - 66mm	A04281	3
7 - 69mm	A04282	3
8 - 72mm	A04283	3
9 - 75mm	A04284	3
10 - 78mm	A04285	3

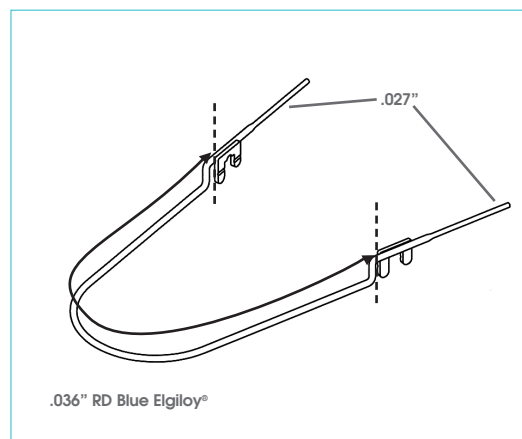

3D® Wilson®/Dillehay Preformed Lingual Arch – with distal bend

- .036" diameter Blue Elgiloy
- Easy vertical placement and removal
- Holding arch for extraction and non-extraction cases
- Lower molar rotation, torquing and tipping

Size	Order Number	Package Contains
3 - 57mm	A04252	3
4 - 60mm	A04253	3
5 - 63mm	A04254	3
6 - 66mm	A04255	3
7 - 69mm	A04256	3
8 - 72mm	A04257	3
9 - 75mm	A04258	3
10 - 78mm	A04259	3

